



# POWERFIT





USER GUIDE **app**





# USER GUIDE

## Content

	PARTS LIST	3-4
	ASSEMBLY INSTRUCTIONS	5-8
	FUNCTION CONTROLS	9-26
	HEALTHY & SMART APP	27-44
	CARE & MAINTENANCE OF UPHOLSTERY	45-46

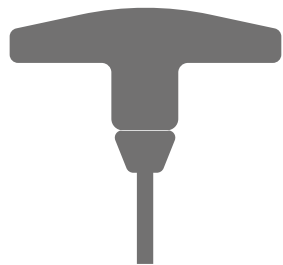

ALLEN WRENCH **X1**



**X4** 1/4 X 16mm (ARMREST)

**X1** 1/4 X 16mm (SPARE)

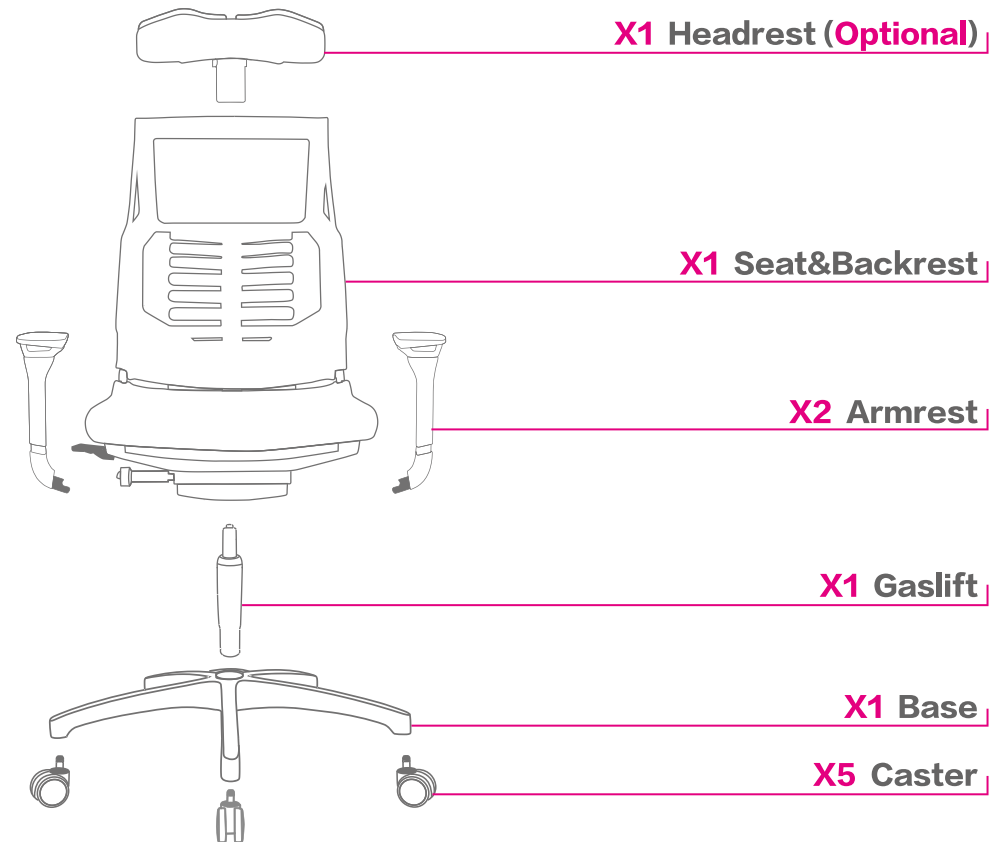

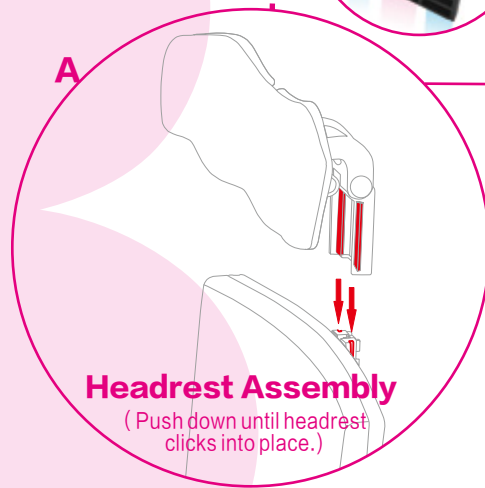
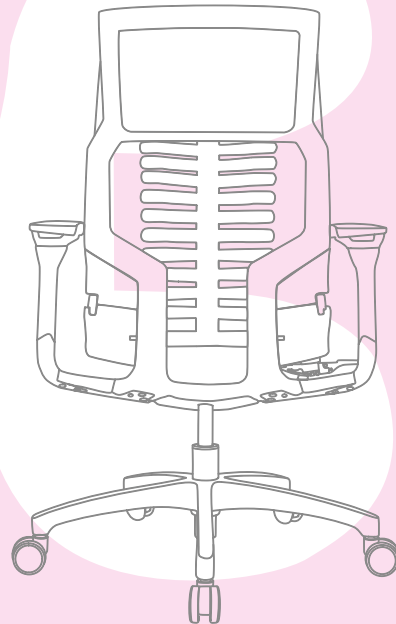
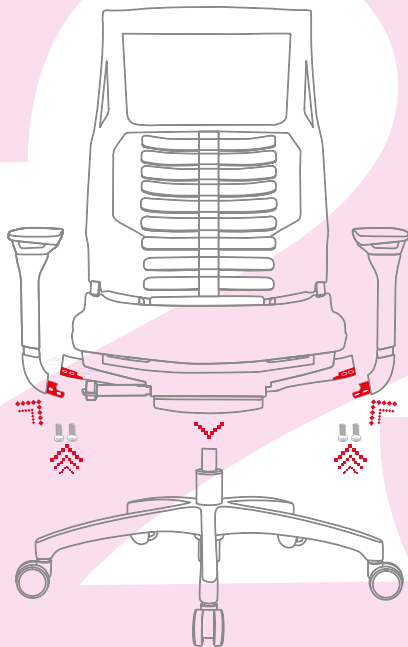
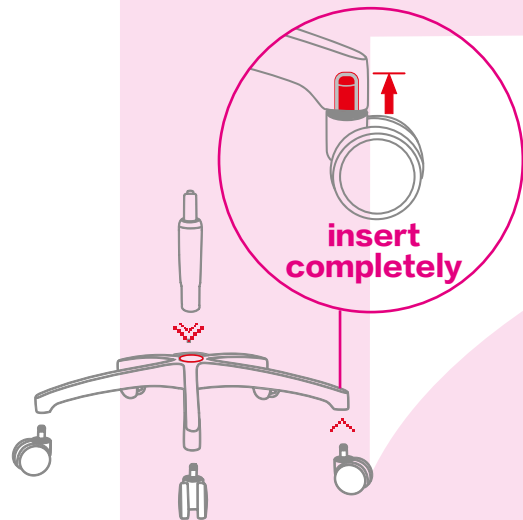

**Attention:**

Align at slots then push headrest down.

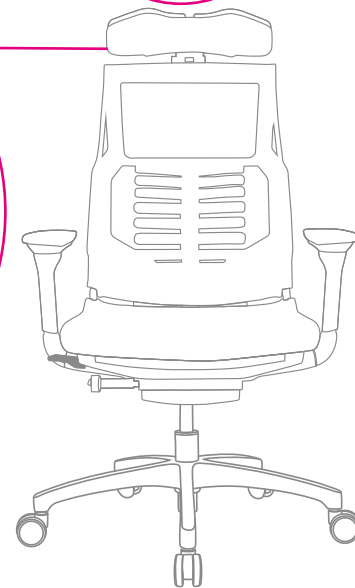
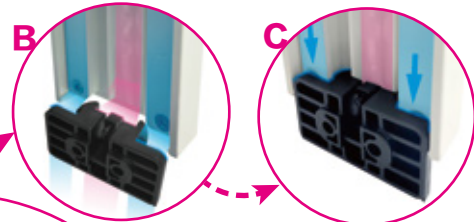

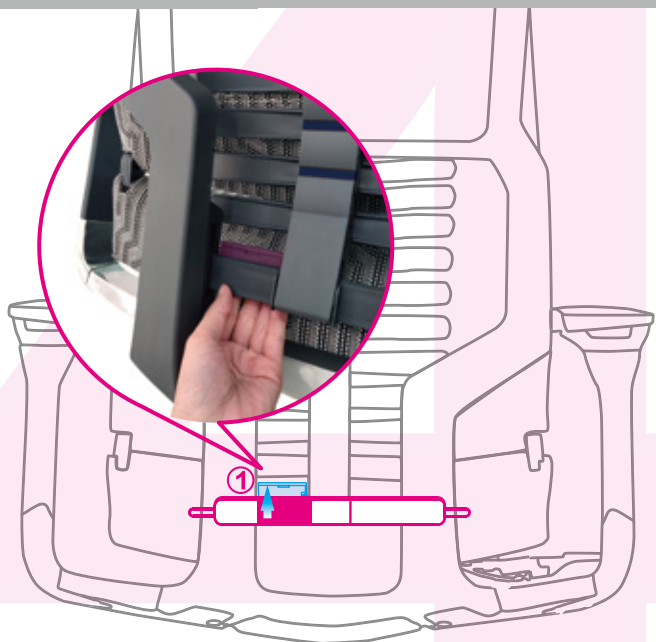

① Push up the battery box to open it.

AAA    Backrest & Seat



② Turn over the battery box, push the battery box cover out as per arrow direction to install batteries.



③ Slide the battery box from top to bottom to close it.

① Slide the seat depth forward.

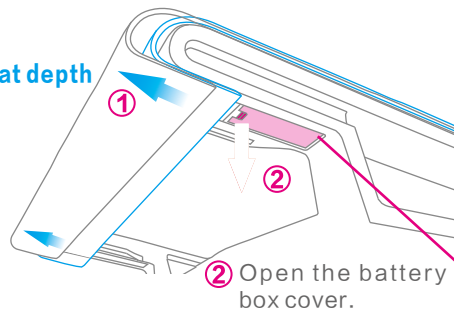

② Open the battery box cover.

③ Install batteries

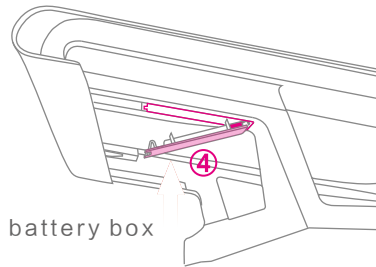

④ Close the battery box cover.

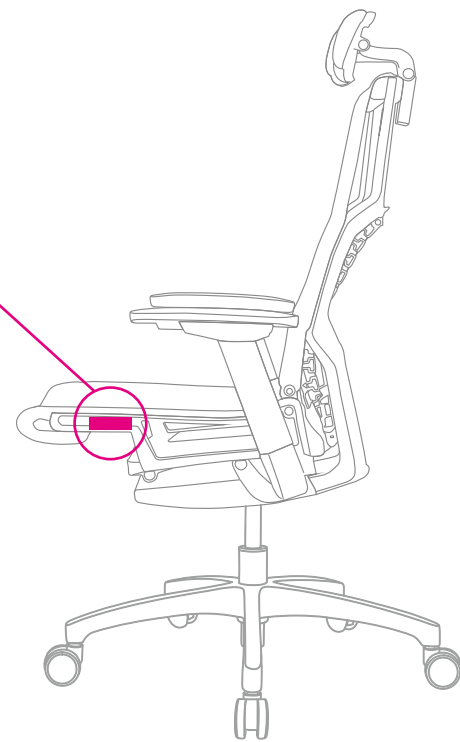

# FUNCTION CONTROLS

- 1 SINGLE LEVER CONTROL**
  - SEAT HEIGHT ADJUSTMENT
  - BACK TILT & LOCK ADJUSTMENT
- 2 BACK TILT ADJUSTMENT AND BACK TILT LOCK**
- 3 BIONIC LUMBAR POSITION ADJUSTMENT**
- 4 3D ARMREST**
- 5 SEAT DEPTH ADJUSTMENT**
- 6 LIVEMOTION LUMBAR AUTO-TRACKING SYSTEM**
- 7 5D HEADREST(OPTIONAL)**
- (8) HEALTHY & SMART APP**



**1 2 FUNCTION CONTROLS INTUITIVE ADJUSTMENT**



**BACK TILT TENSION**

To loosen the tilt tension, turn the handle counterclockwise so "LOOSEN" is at the top.

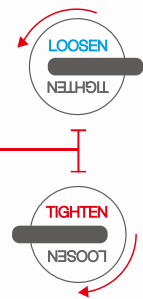

To tighten the tilt tension, turn the handle clockwise so "TIGHTEN" is at the top.

**SEAT HEIGHT**

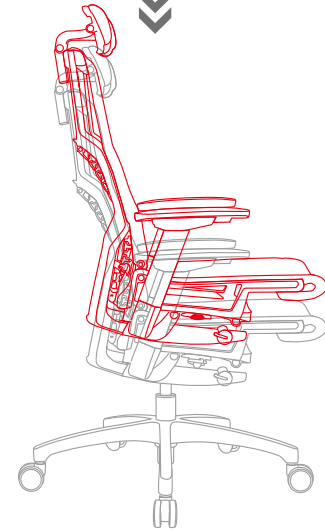

Pull the lever up and hold to raise or lower seat height. Release the lever to lock seat in position.

**BACK TILT**

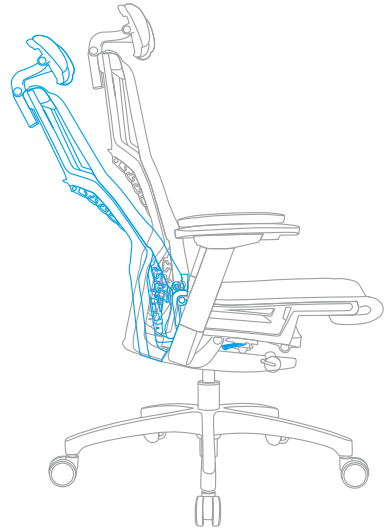

Push the lever backward to allow backrest tilt. Return the lever to the center to lock backrest. There are 4 locking positions.



## BIONIC LUMBAR POSITION ADJUSTMENT

### To increase lumbar support:

Hold both handles of the lumbar adjustment and lift upwards slowly to increase the lumbar support. There are total 7 levels of adjustment. Please adjust slowly.

### To reduce lumbar support:

Lift the handles “ ” to the top and push down. The Bionic Spine will return to its original position. Then adjust to the optimal position by lifting the handles slowly.

**Attention:** While adjusting the Bionic Spine, lean forward so there is no pressure on the back while making the adjustment.





4 5 FUNCTION CONTROLS ARMREST & SEAT DEPTH ADJUSTMENTS

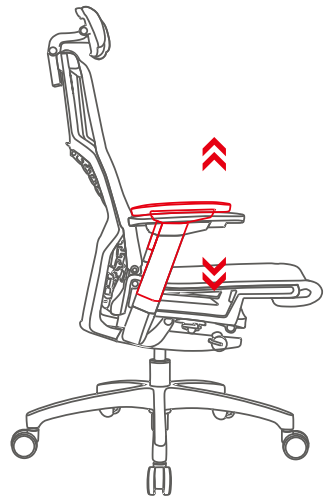

HEIGHT

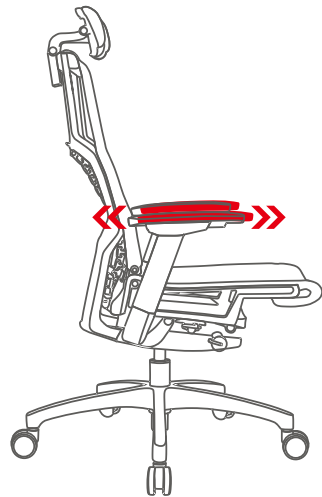

DEPTH

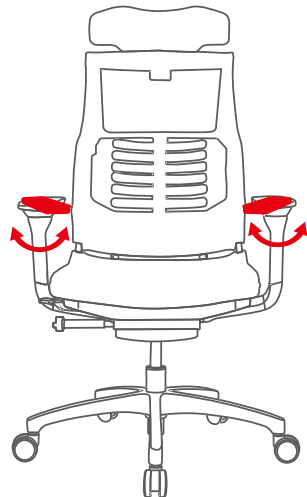

ANGLE

« SEAT DEPTH »

Hold both sides of the seat front edge.  
Slide forwards or backwards to  
increase or reduce seat depth.



# LIVEMOTION

## LUMBAR AUTO-TRACKING SYSTEM



### 6 LIVEMOTION LUMBAR AUTO-TRACKING SYSTEM

Delivers full support and superior comfort to user's lumbar & sacrum area when the user changes sitting posture. User's lumbar can be supported fully and automatically all the time in any sitting position.



1D Headrest Bar Height Adjustment



2D Headrest Height Adjustment



3D Tilt Adjustment



4D Angle Adjustment



5D Comfort Flex Adjustment

## 1D Headrest Bar Height Adjustment

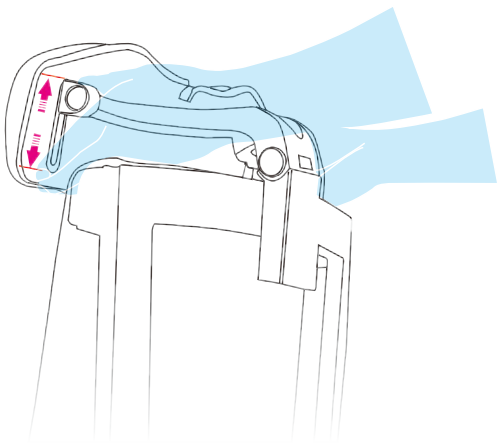

Hold both sides of headrest and move headrest up or down to adjust the height.

## 2D Headrest Height Adjustment

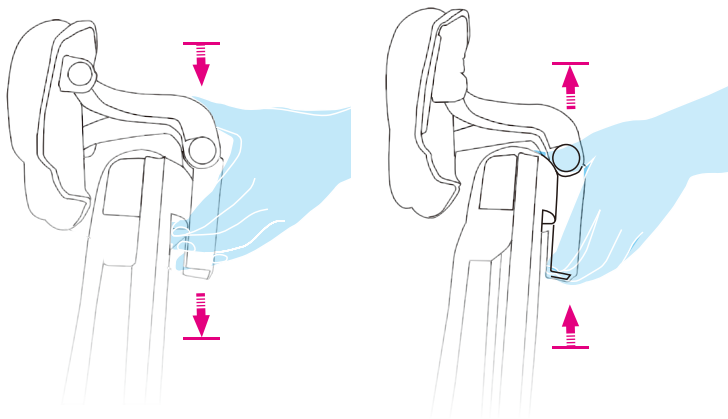

Hold the headrest support bar and move the bar up or down to adjust the height.

## 3D Tilt Adjustment

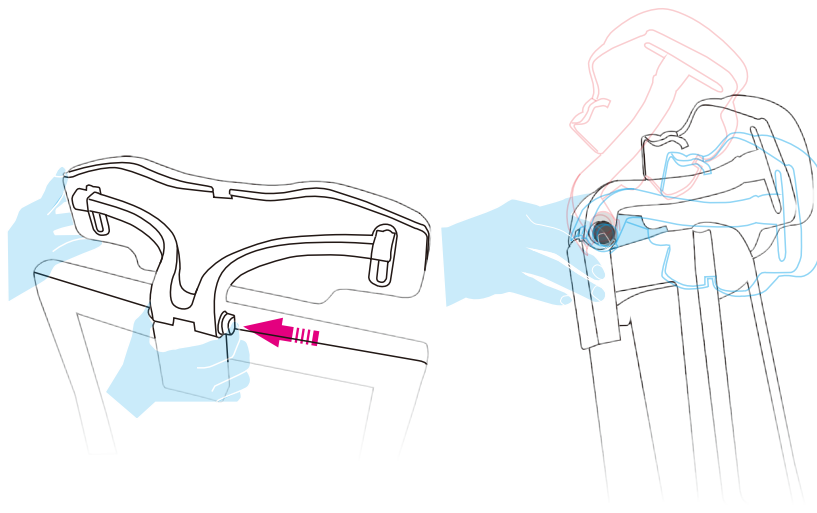

Press the button on the right side of headrest support bar when seated and move the headrest forwards or backwards to tilt the headrest. Release the button to lock the position.

## 4D Angle Adjustment

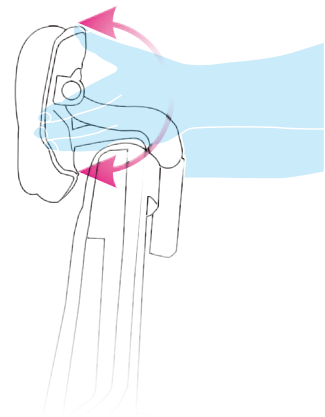

Hold both sides of the headrest and rotate forwards or backwards to adjust the angle.

# HEALTHY LUMBAR POSITIONS SETTING GUIDANCE

## Male

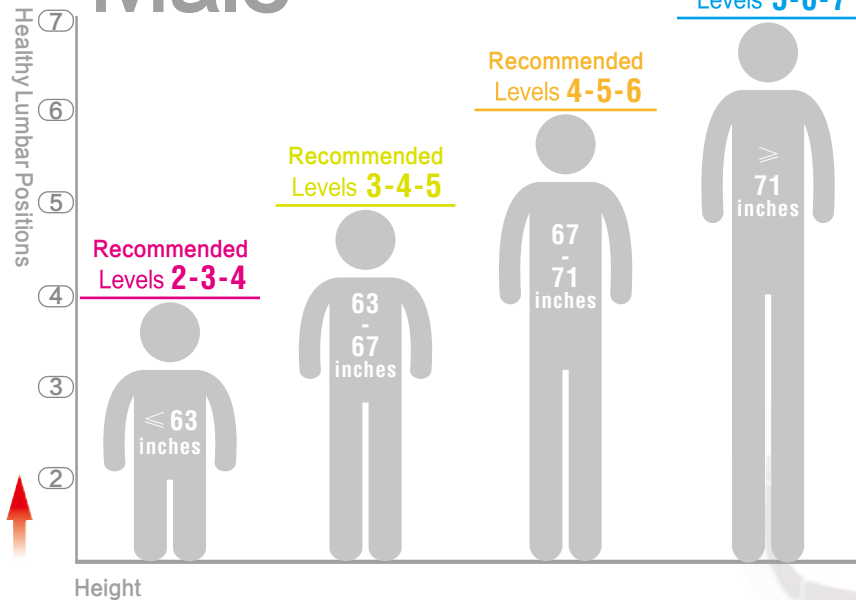

## Female

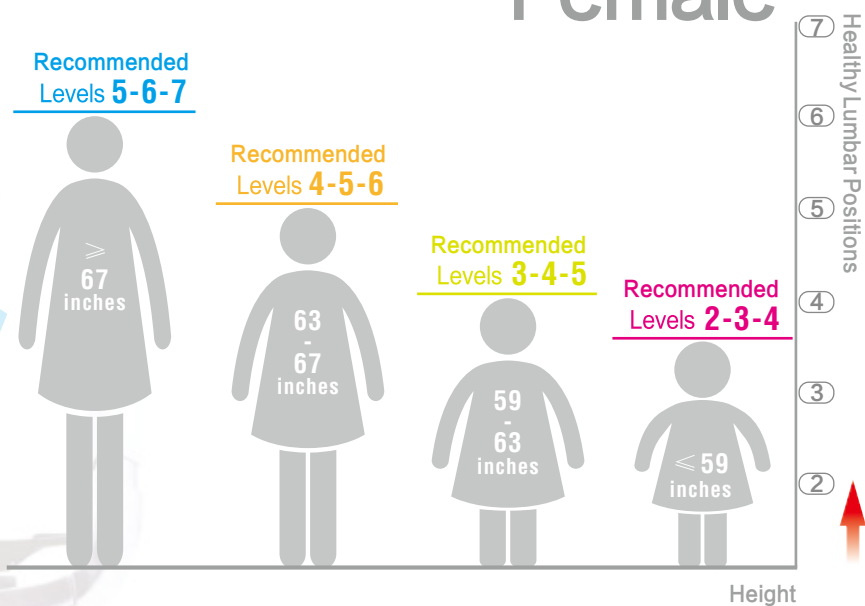

\* You can adjust bionic spine positions by yourself according to different body needs when seated. If your lumbar & back spine are more tired, you can adjust bionic spine to 1 position higher than recommended below to increase spine support. When you are in the recommended position, reduce 1 position if you feel too much support on spine.

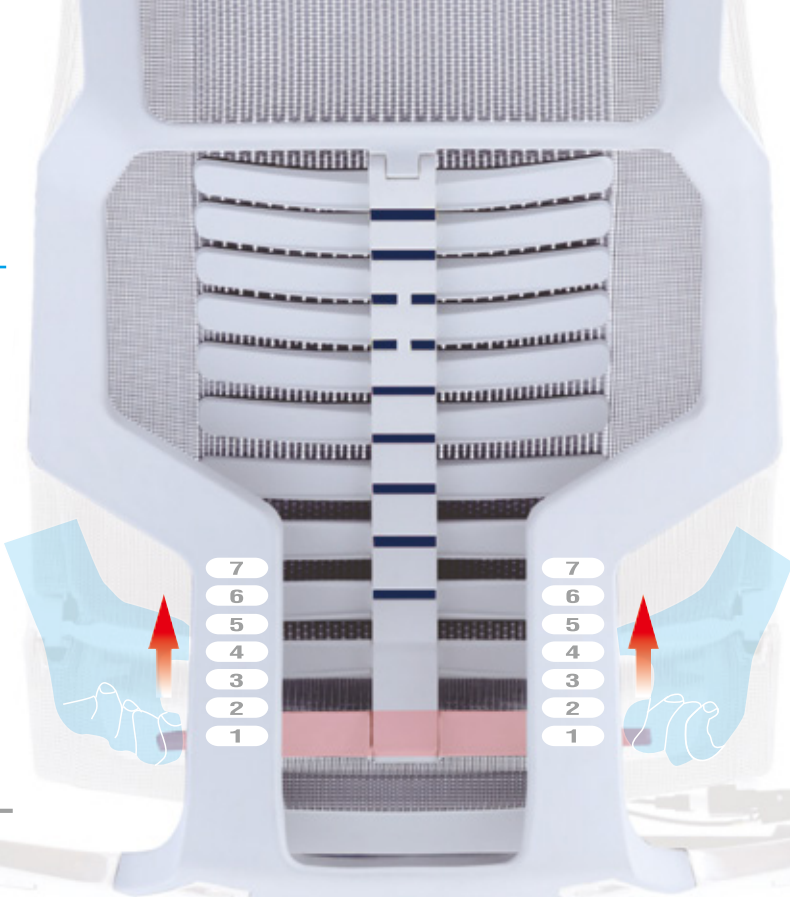



### Correct Sitting Posture

Sit on seat cushion fully (your hips should touch chair's back). This is the key to providing full and correct support to your back, hips and legs.

- 1 Keep head and neck straight against headrest with eyes looking straight ahead.
- 2 Body against backrest, ensuring good back support.
- 3 Keep elbows bent at 90° angle, let hands drop naturally and relax your shoulders.
- 4 Keep knees bent at 90° angle.
- 5 Keep 2~3 inches between front seat edge to behind knees.
- 6 Feet flat on the floor or on a footrest.



### Neck support

Powerfit 5D (double height, tilt, angle & shape) adjustable headrest can provide multi-directional support to your neck and reduce pressure on your neck.

### Back support

Bionic spine is the best solution for back pain. It can provide 300% more support to your thoracic spine, lumbar spine and sacrum spine.

### Lumbar support

LIVEMOTION lumbar system can automatically provide full and superior support to your lumbar area to solve lack of lumbar support while reclining.

### Arm support

3D Armrest allows forearms to be supported to rest comfortably while using keyboard or mouse or reclining to prevent unsupported arms.

### Hips support

Powerfit intelligent seat can deliver comfortable and breathable support to avoid hip pain.

### Thigh support

Front seat depth adjustment suits different sized users and gives good support to thighs. It can disperse pressure on hip to contribute to better blood circulation.



# HEALTHY & SMART APP





## 1 APP SETTING

-  DOWNLOAD  LOGIN 29-30

## 2 USE & ADJUSTMENT

-  CREATE PROFILE  CONNECT  LUMBAR PROTECTION SETTING 31-34

## 3 UBIQUITOUS HEALTHCARE

-  FUNCTIONS OF THE HOME PAGE 35-36
-  HEALTHY SITTING POSTURE WARNING 37
-  SEDENTARINESS WARNING 38
-  SITTING POSTURE EVALUATION 39
-  SITTING POSTURE STATISTICS 40

## 4 FACILITIES MAINTENANCE

-  SETTINGS  FAQ 41-43

# THE WORLD FIRST CHAIR WITH SMART APP



**DOWNLOAD**



Apple store



Android platform

Search  and **download APP.**

 In order to achieve APP smart functions, please set your smart phone authority management.

**APPLE**  Settings-Notice-COMFORT SMART-Allow notice

**ANDROID**  Settings-Application Management-COMFORT SMART-Notice- Turn on lock screen display

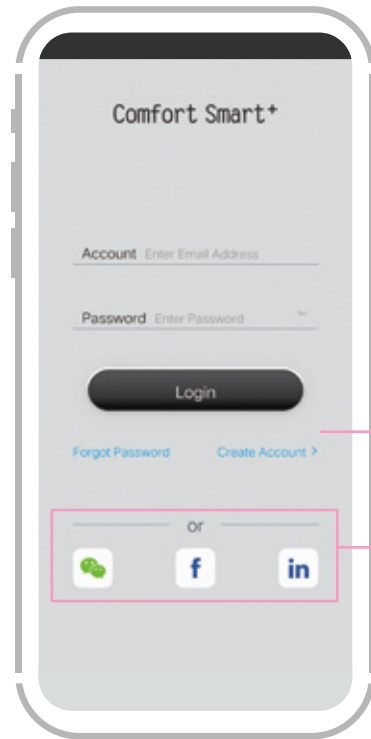
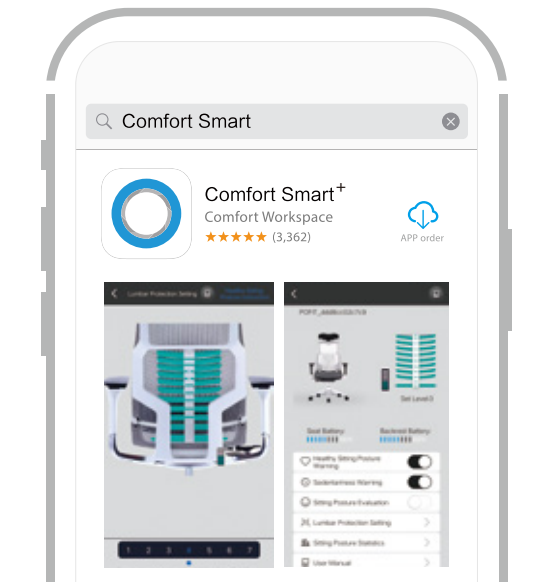

**2 WAYS TO LOGIN**

1

2

Log in via third-party (WeChat, Facebook or LinkedIn) and then turn to "My Profile" (For details of personal information, please refer to P-31).

OR

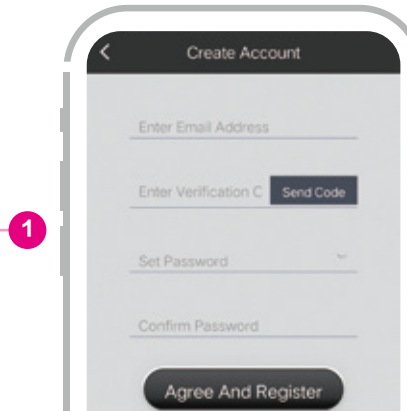

**CREATE ACCOUNT**

For 1st time using app, please register account by email to get verification code and set password.

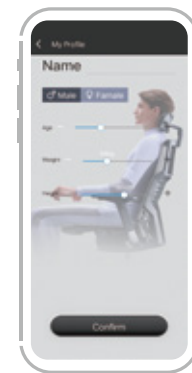

**CREATE PROFILE**

Enter your personal information

AFTER LOGGING IN 

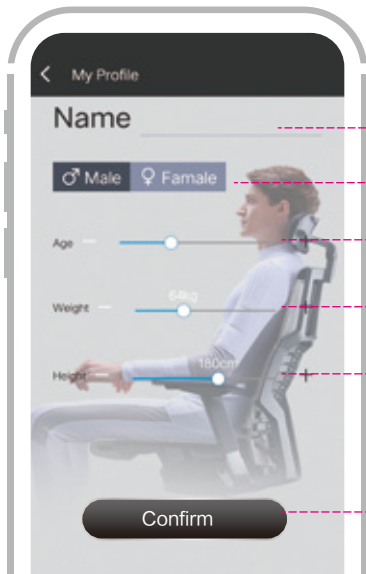

1 Name

2 Gender

3 Age

4 Weight

5 Height

Then press

Confirm



Remind to **turn on** bluetooth.

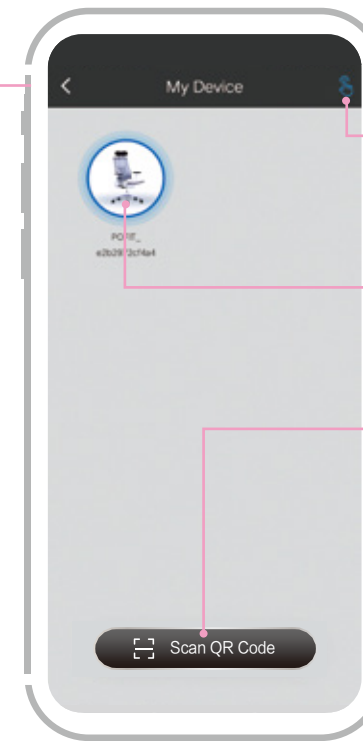

or  Connecting by entering ID code

 Connecting by Bluetooth

RECOMMENDED

or  Connecting by scanning QR code

\*For more than 2pcs Powerfit with APP nearby, it is recommended to scan QR code for more accurate connection.



The QR Code and ID No. are stickered on the seat battery box cover.



**CONNECT**

3 ways to connect your Powerfit chair.

App can guide users to adjust to the best position for lumbar support through data analysis to help maintain user's health.

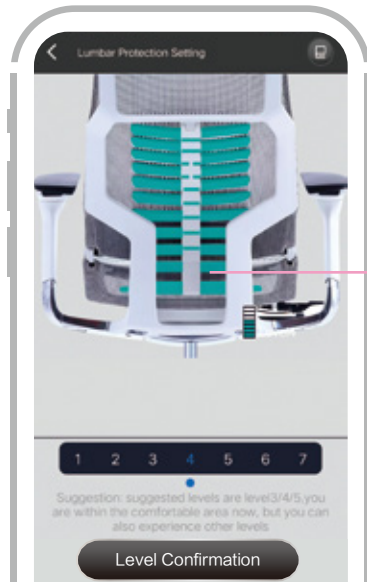

### Situation A Suggested Levels

Lumbar levels are within comfortable ones  
The bionic spine becomes green

You can confirm this level if you feel the level is the most comfortable position. You can try other levels to find the best comfortable position. Press "Level Confirmation" button

to save.

**Level Confirmation**  
Save this level as the most comfortable level

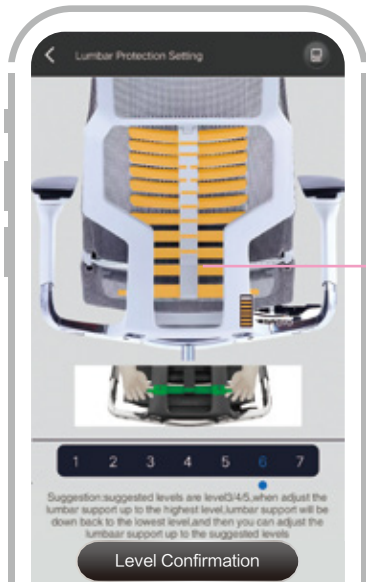

### Situation B Too High Levels

Lumbar level is too high  
The bionic spine becomes yellow

APP will advise you to adjust lumbar level down to the suggested levels. You can try other levels to find the most comfortable position.

Press "Level Confirmation" button

to save.

**Level Confirmation**  
Save this level as the most comfortable level

### To Adjust Bionic Spine

To reduce bionic spine position, lift the handles to the **Top (7th level)** and push down to the 1st level, then adjust to the recommended level.



### Situation C Too Low Levels

Lumbar level is too low  
The bionic spine becomes red

APP will advise you to adjust lumbar level up to the suggested levels. You can try other levels to find the most comfortable position. Press "Level Confirmation" button

to save.

**Level Confirmation**  
Save this level as the most comfortable level

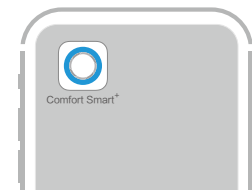

When finished all settings, login app to access to functions home page directly

2 Seat & Back Power Display

3 P-37 Healthy Sitting Posture Warning

4 P-38 Sedentariness Warning

5 P-39 Sitting Posture Evaluation

6 P-33-34 Lumbar Protection Setting

7 P-40 Sitting Posture Statistics

8 User Manual

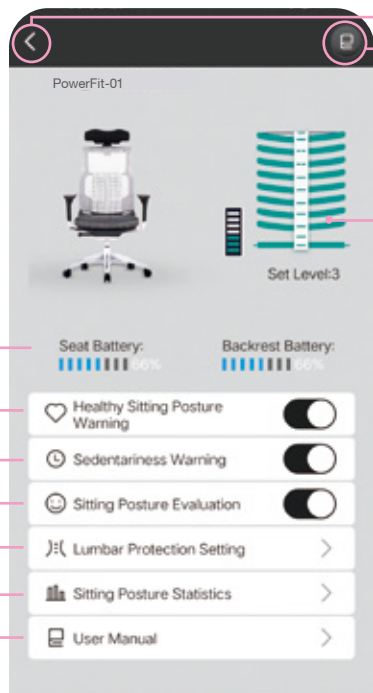

1 P-33-34 3 situations of set level

A **GREEN** when lumbar support is at the recommended level

B **YELLOW** when lumbar support is above the recommended level

C **RED** when lumbar support is below the recommended level



When APP detects **lumbar levels have been changed**, APP will send a reminder. If you press "YES", you will get direct access to "Lumbar Protection Setting".

9 **HEALTHY SITTING POSTURE GUIDE**

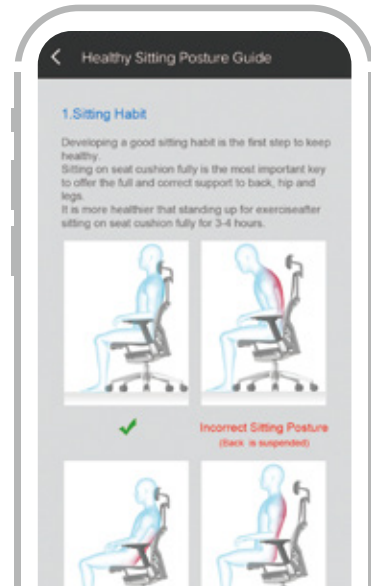

10 **CONNECTED CHAIRS DISPLAY AREA**

When you reach the home page functions, click "back" to access to this connected chairs show area. This page can add (click ) and switch connection with other Powerfit chairs quickly. This area will record and display all connected chairs.

**UNLINK MY CHAIR**

Press and hold the chair picture to unlink the chair. If confirm "unlink", the chair will not appear in the display area. It will not connect automatically when you login again. You need to re-connect the chair to re-link it.

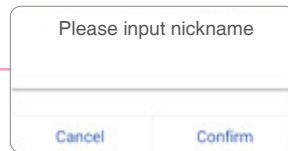

Press and hold chair name to rename your chair. Connection is successful if the picture circle becomes **blue**.

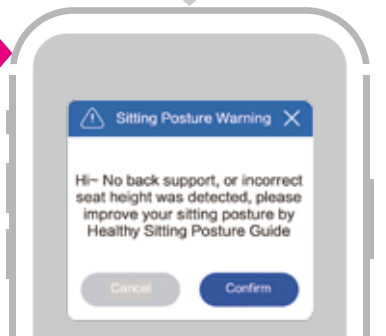
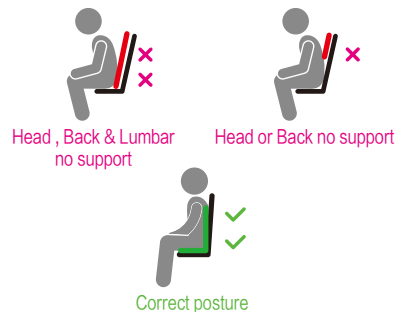

### HEALTHY SITTING POSTURE WARNING

If APP detects any incorrect sitting posture, it will send a warning message to your phone. You can set the warning to alert you every **three, five or ten minutes**.

Healthy Sitting Posture Warning

“Yes” – access to “Healthy Sitting Posture Guide”



### SEDENTARINESS WARNING

When you **turn on the Sedentariness warning**, the APP will detect your activity status automatically. It will send a message to remind you to get up to move when you sit still for too long. You can set the warning to alert you every **two, three or four hours**.



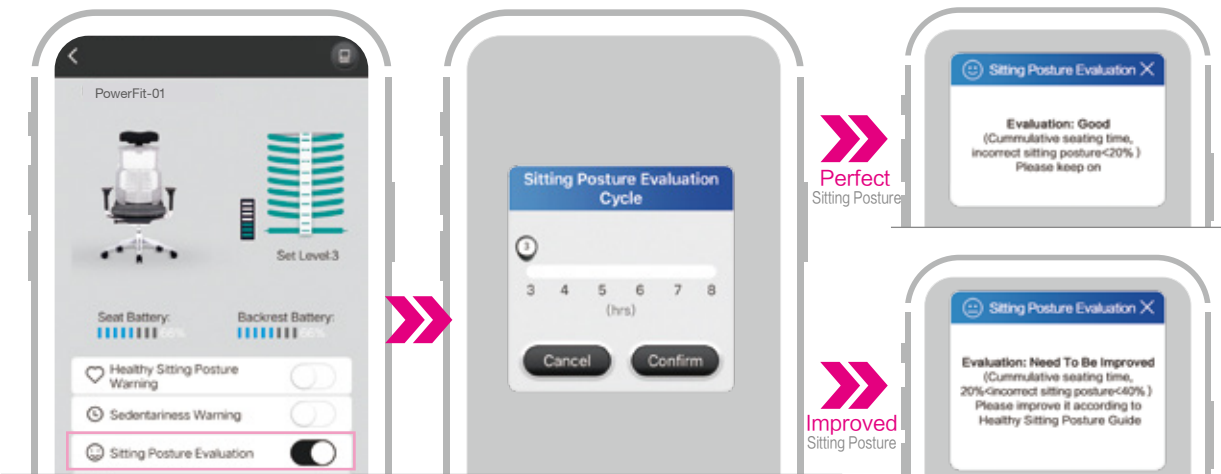

### SITTING POSTURE EVALUATION





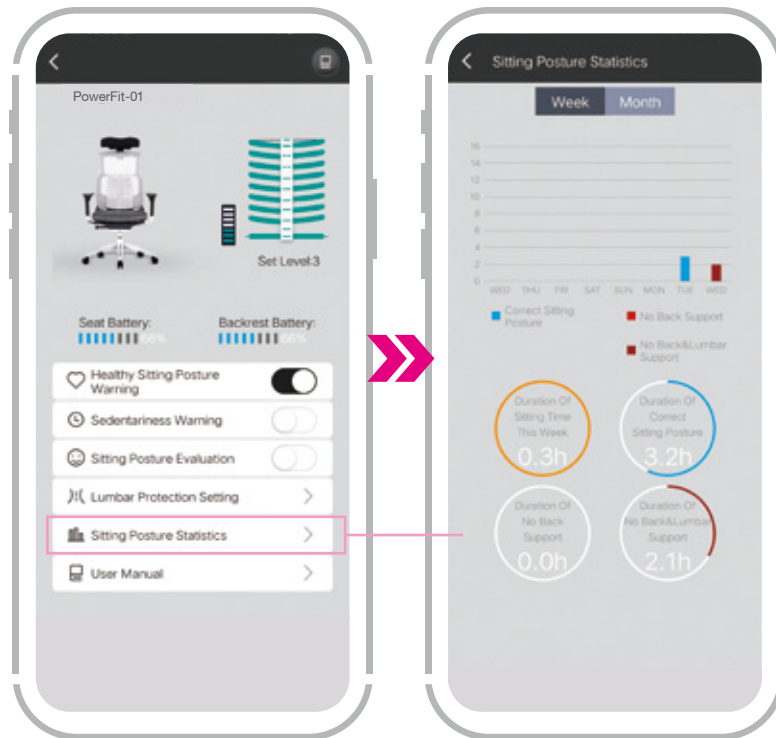

Turn on the Sitting Posture Evaluation function. APP will calculate how much time you sit correctly and how much time you sit incorrectly every 3~8 hours and will send a evaluation message to your phone. This function can help users to develop good & healthy sitting habits.

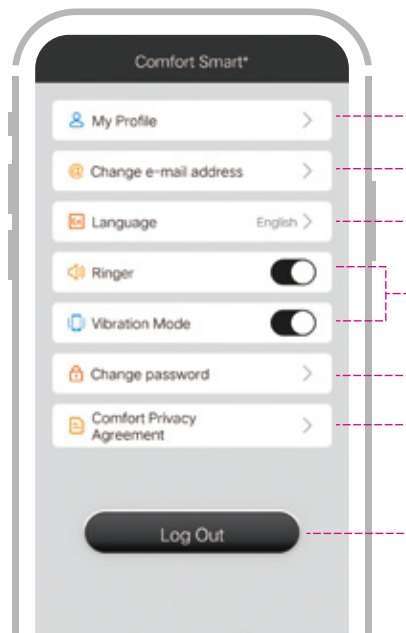
### SITTING POSTURE STATISTICS

Review sitting posture status weekly or monthly by clicking on "Sitting Posture Statistics". Your total sitting time, correct sitting posture time and 2 types of incorrect sitting posture time (no head or back support and no head, back & lumbar support) are recorded.



**SETTINGS**

-  Review & revise personal information
-  Change e-mail address
-  Language: Chinese, English, Japanese, Spanish, Korean
-  Turn on the Ringer and Vibration to get sitting posture status notifications. Never miss any healthy reminders.
-  Change password
-  Comfort Privacy Agreement
-  You can switch account after logging out.

**1. No device found or cannot connect device**

- When you sit on the chair, lean back on the backrest to “wake” the seat and backrest sensors;
- Make sure your Bluetooth is turned on, your smart device is close to your chair and there is working internet;
- Remove the seat batteries and put them back in to reset the seat sensor;
- Restart “Comfort Smart+”;
- Restart your smart device;
- If you are still unable to connect the App to your chair, your chair may be connected to another smart device.

**2. Cannot connect the saved chair in “Connected Chairs Display Area”**

- Press and hold the icon to delink the saved chair and then connect your chair again.

**3. After connecting successfully, the display of current level (in “lumbar protection setting” ) doesn’ t change when user adjusts the lumbar support**

- Data transmission may be delayed after you are successfully connected. This should resolve itself within 20 seconds;
- Your backrest may still be “asleep”. Please lean back on the backrest to “wake” the backrest connection.

**4. Battery level suddenly goes to “0”**

- Seat and backrest sensors enter hibernation after 5 minutes of no use. Please sit on the chair and lean on the backrest to “wake” both sensors.

**5. Your smart device does not automatically connect to your chair**

- Make sure “Comfort Smart+” is running in the background;
- Your App will automatically connect to the chair used last.

**6. Your smart device does not connect to your chair**

- Seat and backrest sensors enter hibernation after 5 minutes of no use. Please sit on the chair and lean on the backrest to “wake” both sensors;
- Restart “Comfort Smart+”;
- Remove the seat batteries and put them back in to reset the seat sensor;
- Your chair may have been connected to someone else’ s app when your app was disconnected. Two devices cannot be connected to one chair at the same time.

**7. If you did not receive a verification code, please check your junk mail.**

\* If you are still having problems with your App or connecting to your chair, please call 1-800-637-0005 and follow the prompts for customer service.



3 improper use may cause **bionic spine retroflexion**

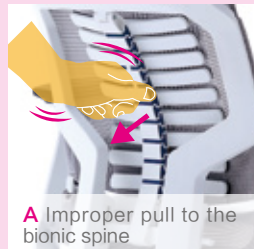

**A** Improper pull to the bionic spine



**B** Improper push to the backrest



**C** Extra pillow beside the backrest



**Bionic spine retroflexion**



**Solution:**

When there is a bionic spine retroflexion, push the bionic spine lightly to get it back to the normal shape and structure.



### OUR PROMISE

They say with age comes wisdom. And while we've learned a lot since we sold our first office chair in 1979, even then we knew that superior craftsmanship and design are essential ingredients in delivering real value for our customers. All these years later, those three simple pillars still stand behind our promise of exceptional seating with every chair we sell.

DESIGN CRAFTSMANSHIP VALUE  
Eurotech. Sit Smarter.

### THE EUROTCH WARRANTY

For all products except for 24/7 chairs (see below), Eurotech warrants to the original purchaser all components for the life of the product with the exception of upholstery and foam, which will be warranted for five years.

For 24/7 chairs, Eurotech warrants to the original purchaser of all 24/7 chairs all components for 10 years with the exception of upholstery and foam which will be warranted for 2 years.

Eurotech warrants to the original purchaser that all parts will be free from material defects. Eurotech does not warrant any aftermarket hardware that is installed on the product.

Eurotech does not warrant any aftermarket hardware that is installed on the product.

Eurotech's warranty is limited to the normal use of the product in a forty hour work week and a 275lb. weight limit unless otherwise noted.

Eurotech shall NOT be liable for consequential or incidental damage arising from any product defect.

Eurotech's warranty is limited to replacement or repair and does not cover cost of transportation and labor. There are no other warranties expressed or implied other than those specifically described.

Eurotech does not warrant customer's own material.